

DEVELON

Mini Excavator

DX50Z-7



Engine

Make	DEVELON
Model	D18
Number of cylinders	3
Rated power, gross (hp per SAE J1995)	48.8 hp (36.4 kW) @ 2200 rpm
Rated power, net (hp per SAE J1349)	47.1 hp (35.1 kW) @ 2200 rpm
Max. torque, net (SAE J1995)	133.0 lbf.-ft. (18.4 kgf-m) @ 1600 rpm
Displacement	146.0 in. ³ (2.4 L)
Bore and stroke	3.5" x 3.7" (90 mm x 94 mm)
Starter	12 V, 3.6 hp (2.7 kW)
Battery	12 V, 100 AH
Alternator	12 V, 90 A
Air cleaner	Double elements

Hydraulics

Main pumps	1 x 37 gpm (139.0 L/min.)
Pilot pump (gear design)	-
Relief pressure	3553.4 psi (249.8 kg/cm ²)

Maximum System Pressure

Boom/arm/bucket (normal mode)	4206.1 psi (295.7 kg/cm ²)
Swing (crossover relief)	3129.0 psi (220.0 kg/cm ²)

Undercarriage

Upper rollers (each track)	1
Lower rollers (each track)	4
Number of shoes (links per side)	Single assembly (rubber)

Swing Mechanism

Swing speed	9.8 rpm
Swing torque	9982.0 lbf.-ft. (1380.0 kgf-m)

Drive System

Travel speed (low – high)	1.6 – 2.7 mph (2.6 – 4.4 km/h)
Traction force, max. (drawbar pull)	11310.0 lbf. (5130.0 kgf)
Max. grade	70% (35°)

Environment

Sound level (ISO 6395)	97 dB(A)
Cabin sound level (ISO 6396)	78 dB(A)

Refill Capacities

Fuel tank	17.4 gal. (66.0 L)
Cooling system (radiator capacity)	2.2 gal. (8.3 L)
Engine oil	1.7 gal. (6.3 L)
Final drive (each side)	0.2 gal. (0.9 L)
Hydraulic system	27.7 gal. (105.0 L)
Hydraulic tank	12.7 gal. (48.0 L)

All capacities are approximate values. Always refer to the machine's OM for exact refill levels. Check the dipstick, level eye, level plug, etc., to achieve the correct level.

Hydraulic Cylinders

Boom ¹ (1) bore x rod diameter x stroke	3.7" x 2.2" x 26.7" (95 mm x 55 mm x 678 mm)
Arm ^{1,2} (1) bore x rod diameter x stroke	3.1" x 2.2" x 28.6" (80 mm x 55 mm x 726 mm)
Bucket ¹ (1) bore x rod diameter x stroke	2.8" x 1.8" x 23.6" (70 mm x 45 mm x 600 mm)
Swing – boom ¹ (1) bore x rod diameter x stroke	3.7" x 2.4" x 17.7" (95 mm x 60 mm x 449 mm)
Blade ¹ (2) bore x rod diameter x stroke	4.3" x 2.4" x 7.8" (110 mm x 60 mm x 197 mm)

¹ Cushion on rod end

² Cushion on base end

The piston rods and cylinder bodies are made of high-strength steel. A shock-absorbing mechanism is fitted in all cylinders to ensure shock-free operation and extended piston life.

Dimensions

		Standard Arm & HVAC Cabin (US20/US40)	Standard Arm & Canopy (US30/US50)
Boom type		One-piece boom	
Arm type		Standard arm	
Bucket type (SAE)		General-purpose	
Track type		Fixed (rubber)	
Shipping length	A	17' 8.1" (5386 mm)	
Overall height	B	8' 5.4" (2575 mm)	
Shipping width	C	6' 6.0" (1980 mm)	
Tail swing radius	D	3' 3.4" (1000 mm)	
Tail swing overhang (rear)*		-	
Tail swing overhang (side)	E	1.6" (40 mm)	
Counterweight clearance	F	2' 0.7" (628 mm)	
Upper structure width	H	5' 8.9" (1750 mm)	
Cabin height above house	I	3' 2.9" (987 mm)	
Tumbler distance	J	6' 6.4" (1990 mm)	
Overall track length	K	8' 2.3" (2497 mm)	
Undercarriage width	L	6' 6.0" (1980 mm)	
Track gauge width	M	5' 2.2" (1580 mm)	
Track width	N	1' 3.8" (400 mm)	
Track height	O	1' 10.1" (562 mm)	
Car body clearance	P	8.2" (208 mm)	
Blade height	Q	1' 1.8" (350 mm)	
Blade clearance	R	1' 6.5" (469 mm)	
Max. blade cut, below ground	S	1' 5.8" (451 mm)	

*Not shown on diagram
Less than zero indicated as "-"

US40/US50 packages include rotating piping as standard.

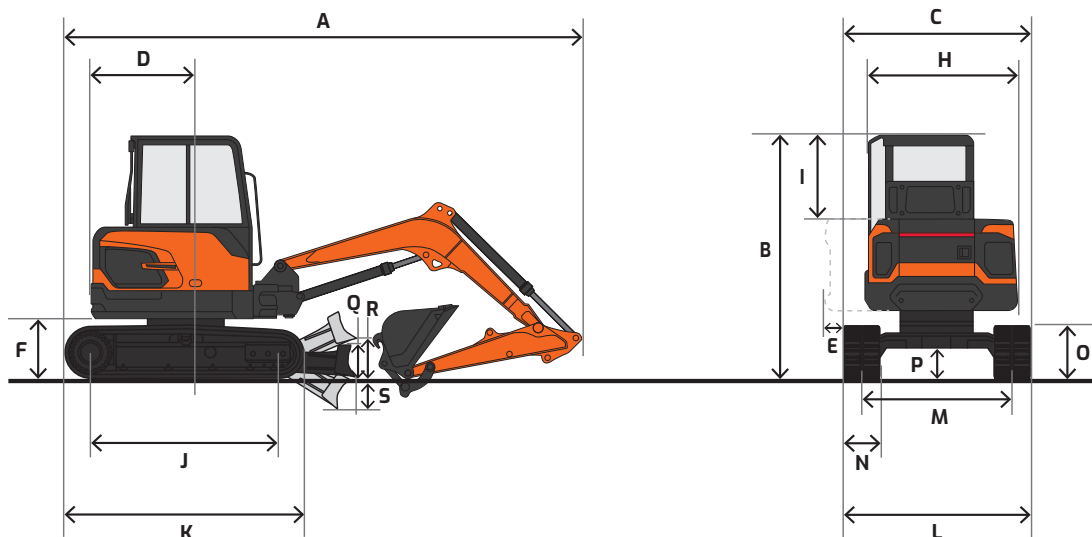

Working Range

		Standard Arm & HVAC Cabin (U520/U540)	Standard Arm & Canopy (U530/U550)
Boom length		8' 10.3" (2700 mm)	
Arm length		4' 9.1" (1450 mm)	
Bucket capacity (SAE)		5.7 ft. ³ (0.16 m ³)	
Max. digging reach	A	19' 6.1" (5945 mm)	
Max. digging reach (ground)	B	19' 0.4" (5800 mm)	
Max. digging depth	C	11' 5.0" (3480 mm)	
Max. dumping height	D	12' 6.4" (3820 mm)	
Max. digging height	E	18' 3.5" (5575 mm)	
Max. bucket pin height	F	15' 5.4" (4710 mm)	
Max. vertical wall depth	G	10' 3.6" (3140 mm)	
Max. vertical digging radius	H	11' 1.5" (3390 mm)	
Min. swing radius	I	8' 3.2" (2520 mm)	
Boom swing – left/right		60° / 53°	
Digging force, bucket		7606.0 lbf. (3450.0 kgf)	
Digging force, arm		5181.0 lbf. (2350.0 kgf)	
Counterweight		595 lb. (270 kg)	
Operating weight		11988 lb. (5438 kg)	12046 lb. (5464 kg)
Ground pressure		4.41 psi (0.31 kg/cm ²)	

U540/U550 packages include rotating piping as standard.

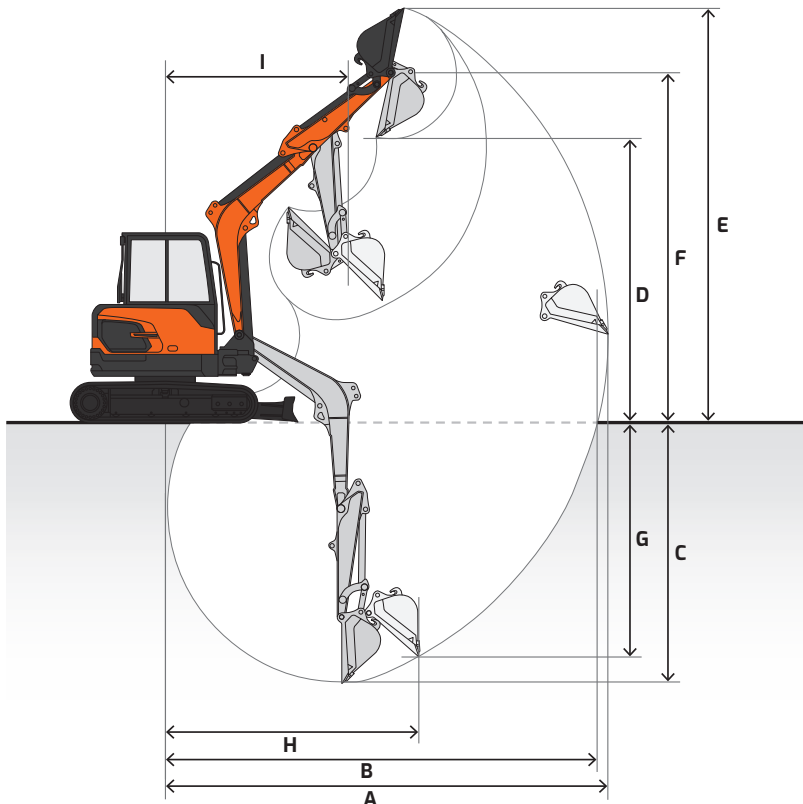

Bucket

	Standard Arm & HVAC Cabin (US20/US40)	Standard Arm & Canopy (US30/US50)
Boom	8' 10.3" (2700 mm)	
Arm	4' 9.1" (1450 mm)	
Shoe size	1' 4.0" (400 mm)	
Track type	Fixed (rubber)	
Counterweight	595 lb. (270 kg)	

Bucket Type	Model	Capacity* yd ³ (m ³)	Width in. (mm)	Weight lb. (kg)	Height in. (mm)	Length in. (mm)	Number of teeth	Connection/ Type
Quick-Hitch Ditching (QH05GB)	DC05GB-36QH	0.29 (0.22)	36 (914.4)	290 (131.5)	21.0625 (534.9)	26.25 (666.7)	-	Quick-hitch
	DC05GB-42QH	0.35 (0.26)	42 (1,066.8)	325 (147.4)				
	DC05GB-48GH	0.40 (0.30)	48 (2,133.6)	365 (165.5)				
Quick-Hitch Heavy-Duty (QH05GB)	HD05GB-12QH	0.08 (0.06)	12 (304.8)	120 (54.4)	21.1875 (538.1)	33.875 (860.4)	3	Quick-hitch
	HD05GB-18QH	0.13 (0.09)	18 (457.2)	155 (70.3)			4	
	HD05GB-24QH	0.18 (0.14)	24 (609.6)	185 (83.9)			5	
	HD05GB-30QH	0.24 (0.18)	30 (762.0)	220 (99.7)			5	
	HD06GB-36QH	0.30 (0.23)	36 (914.4)	250 (113.4)			6	
Pin-On Ditching	DC05GB-36	0.30 (0.23)	37 (1,854.2)	340 (154.2)	27.0 (685.8)	30.0 (762.0)	-	Pin-on
	DC05GB-42	0.36 (0.27)	43 (1,092.2)	380 (172.4)				
	DC05GB-48	0.42 (0.32)	49 (1,244.6)	420 (190.5)				
	DC05GB-54	0.47 (0.36)	55 (1,397.0)	460 (208.7)				
	DC05GB-60	0.53 (0.41)	61 (1,549.4)	500 (226.8)				
Pin-On Heavy-Duty	HD05GB-12	0.10 (0.07)	12.375 (314.3)	180 (81.6)	26.0 (660.4)	37.25 (933.4)	3	Pin-on
	HD05GB-16	0.12 (0.09)	17 (431.8)	205 (93.0)			4	
	HD05GB-18	0.14 (0.10)	19 (482.6)	215 (97.5)			4	
	HD05GB-24	0.20 (0.15)	25 (635.0)	250 (113.4)			5	
	HD05GB-30	0.24 (0.18)	31 (787.4)	285 (129.3)			5	
	HD05GB-36	0.32 (0.24)	37 (939.8)	500 (226.8)			6	

*Capacity based on ISO 7451 and heaped with a 1:1 angle of repose

· Equipped with bolt-on wear shrouds

· Equipped with bolt-on teeth

· Equipped with bolt-on cutting edge

· These recommendations are given as a guide only and based on typical operating conditions.

Please consult with your DEVELON dealer to properly match buckets and attachments for the application.













US40/US50 packages include rotating piping as standard.

Lifting Capacity

 Rating over front  Rating over side or 360°













DX50Z-7 US20/US40 | Cabin & Standard Arm

Boom: 8' 10.3" (2700 mm) | Arm: 4' 9.1" (1450 mm) | Counterweight: 595 lb. (270 kg) | Dozer Down | Bucket: None | Unit lb. (kg)

A (ft. or m) B (ft. or m)	5' (1.0 m)		10' (2.0 m)		15' (3.0 m)		20' (4.0 m)		25' (5.0 m)		Max. Reach		
													A
20' (4.0 m)											* 1800 * 820	* 1800 * 820	12.89' (3.93 m)
15' (3.0 m)							* 2350 * 1060	1900 860			* 1580 * 720	1460 660	15.21' (4.64 m)
10' (2.0 m)					* 3540 * 1160	2870 1300	* 2740 * 1240	1830 830			* 1560 * 710	1270 580	16.33' (4.98 m)
5' (1.0 m)					* 4910 * 2230	2630 1190	* 3250 * 1470	1730 780	* 2220 * 1010	1230 560	* 1650 * 750	1210 550	16.58' (5.05 m)
Ground Level					* 5440 * 2470	2520 1140	* 3550 * 1610	1660 750			* 1880 * 850	1260 570	16.01' (4.88 m)
-5' (-1.0 m)	* 5160 * 2340	* 5160 * 2340	* 6540 * 2970	5000 2270	* 5140 * 2330	2510 1140	* 3400 * 1540	1650 750			* 2430 * 1100	1450 660	14.50' (4.42 m)
-10' (-2.0 m)			* 6460 * 2930	5140 2330	* 3850 * 1740	2590 1170					* 2800 * 1270	2080 940	11.50' (3.51 m)

DX50Z-7 US20/US40 | Cabin & Standard Arm

Boom: 8' 10.3" (2700 mm) | Arm: 4' 9.1" (1450 mm) | Counterweight: 595 lb. (270 kg) | Dozer Up | Bucket: None | Unit lb. (kg)

A (ft. or m) B (ft. or m)	5' (1.0 m)		10' (2.0 m)		15' (3.0 m)		20' (4.0 m)		25' (5.0 m)		Max. Reach		
													A
20' (4.0 m)											* 1800 * 820	* 1800 * 820	12.89' (3.93 m)
15' (3.0 m)							2090 950	1900 860			* 1590 * 720	1460 660	15.21' (4.64 m)
10' (2.0 m)					3200 1450	2870 1300	2010 910	1830 830	1350 610	1230 560	* 1390 * 710	1270 580	16.33' (4.98 m)
5' (1.0 m)					2950 1340	2630 1190	1910 870	1730 780			* 1330 * 750	1210 550	16.58' (5.05 m)
Ground Level					2830 1280	2520 1140	1840 830	1660 750			* 1380 * 850	1260 570	16.01' (4.88 m)
-5' (-1.0 m)	* 5160 * 2340	* 5160 * 2340	5890 2670	5000 2270	2820 1280	2510 1140	1830 830	1650 750			1600 * 1100	1450 660	14.50' (4.42 m)
-10' (-2.0 m)			6060 2750	5140 2330	2900 1320	2590 1170					* 2310 * 1270	2080 940	11.50' (3.51 m)

A Distance from center of rotation
B Height

NOTE: Lifting capacities are in compliance with SAE 1097 and ISO 10567. Machine in lifting mode with power boost turned on. Load point is the end of the arm. Rated loads shown do not exceed 75% of minimum tipping loads or 87% of hydraulic capacities. Rated loads marked with an asterisk (*) are limited by hydraulic capacities. The least stable position is over the side. The total mass of machine includes the mass of the boom, arm, counterweight, all operating fluids and 165 lb. (75 kg) operator.

US40/US50 packages include rotating piping as standard.

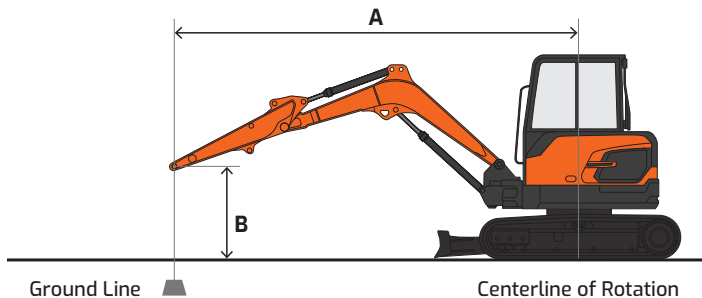













Lifting Capacity

 Rating over front  Rating over side or 360°













DX50Z-7 US30/US50 | Canopy & Standard Arm

Boom: 8' 10.3" (2700 mm) | Arm: 4' 9.1" (1450 mm) | Counterweight: 595 lb. (270 kg) | Dozer Down | Bucket: None | Unit lb. (kg)

A (ft. or m) B (ft. or m)	5' (1.0 m)		10' (2.0 m)		15' (3.0 m)		20' (4.0 m)		25' (5.0 m)		Max. Reach		A
													
20' (4.0 m)									* 5200	3680	* 1770	1210	16.33' (4.00 m)
15' (3.0 m)							* 1210	820			* 1810	1160	16.56' (4.64 m)
10' (2.0 m)					* 1830	1250	* 1420	790			* 1870	1150	16.58' (4.98 m)
5' (1.0 m)					* 2540	1130	* 1680	750	* 1140	530	* 1980	1150	16.40' (5.05 m)
Ground Level					* 2810	1080	* 1840	710	* 5910	3170	* 2140	1190	16.01' (4.88 m)
-5' (-1.0 m)	* 2610	* 2610	* 3310	2160	* 4280	* 4280	* 5220	4720	* 7830	3170	* 2370	1260	15.39' (4.42 m)
-10' (-2.0 m)			* 5750	* 5750	* 6030	* 6030	* 7300	4760	* 7540	3190	* 2750	1370	14.50' (3.51 m)
			3360	2220	* 2000	1120					* 1460	900	

DX50Z-7 US30/US50 | Canopy & Standard Arm

Boom: 8' 10.3" (2700 mm) | Arm: 4' 9.1" (1450 mm) | Counterweight: 595 lb. (270 kg) | Dozer Up | Bucket: None | Unit lb. (kg)

A (ft. or m) B (ft. or m)	5' (1.0 m)		10' (2.0 m)		15' (3.0 m)		20' (4.0 m)		25' (5.0 m)		Max. Reach		A
													
20' (4.0 m)									4150	3680	1320	1210	16.33' (4.00 m)
15' (3.0 m)							900	820			1270	1160	16.56' (4.64 m)
10' (2.0 m)					1380	1250	870	790			1250	1150	16.58' (4.98 m)
5' (1.0 m)					1270	1130	820	750	580	530	1260	1150	16.40' (5.05 m)
Ground Level					1210	1080	790	710	3610	3170	1300	1190	16.01' (4.88 m)
-5' (-1.0 m)	* 2610	* 2610	2540	2160	* 4280	* 4280	* 5220	4720	3610	3170	1380	1260	15.39' (4.42 m)
-10' (-2.0 m)			* 5750	* 5750	* 6030	* 6030	5590	4760	3630	3190	1510	1370	14.50' (3.51 m)
			2610	2220	1250	1120					990	900	

A Distance from center of rotation
B Height

NOTE: Lifting capacities are in compliance with SAE 1097 and ISO 10567. Machine in lifting mode with power boost turned on. Load point is the end of the arm. Rated loads shown do not exceed 75% of minimum tipping loads or 87% of hydraulic capacities. Rated loads marked with an asterisk (*) are limited by hydraulic capacities. The least stable position is over the side. The total mass of machine includes the mass of the boom, arm, counterweight, all operating fluids and 165 lb. (75 kg) operator.

US40/US50 packages include rotating piping as standard.

